P3 JOIST

INSTALLATION

GUIDE

CANADA 2018

BY  **EACOM**
TIMBER CORPORATION

Installing P3 Joist

1. Before laying out floor system components, verify that P3 Joist flange widths match hanger widths. If not, contact your supplier.
2. Except for cutting to length, never cut, drill, or notch P3 Joist flanges.
3. Install P3 Joists so that top and bottom flanges are within 1/2" of true vertical alignment.
4. P3 Joists must be anchored securely to supports before floor sheathing is attached, and supports for multiple-span joists must be level.
5. Minimum bearing lengths are 1-3/4" for end bearings and 3-1/2" for intermediate bearings.
6. When using hangers, seat P3 Joist firmly in hanger bottoms to minimize settlement.
7. Leave a 1/16" gap between the P3 Joist end and a header.
8. Concentrated loads greater than those that can normally be expected in residential construction should be applied only to the top surface of the top flange. Normal concentrated loads include track lighting fixtures, audio equipment, and security cameras. Never suspend unusual or heavy loads from the P3 Joists bottom flange. Whenever possible, suspend all concentrated loads from the top of the P3 Joist, or attach the load to blocking that has been securely fastened to the P3 Joist webs.
9. Never install P3 Joists where they will be permanently exposed to weather or where they will remain in direct contact with concrete or masonry.
10. Restrain ends of floor joists to prevent rollover. Use Certified Rim Board, rim joists, or P3 Joist blocking panels.
11. For P3 Joists installed over and beneath bearing walls, use full depth blocking panels, Certified Rim Board, or squash blocks (cripple members) to transfer gravity loads through the floor system to the wall or foundation below.
12. Due to shrinkage, common framing lumber set on edge may never be used as blocking or rim boards. P3 Joist blocking panels or other engineered wood products such as Certified Rim Board must be cut to fit between the P3 Joists, and a P3 Joist-compatible depth must be selected.
13. Provide permanent lateral support of the bottom flange of all P3 Joists at interior supports of multiple-span joists. Similarly, support the bottom flange of all cantilevered P3 Joists at the end support next to the cantilever extension. In the completed structure, the gypsum wallboard ceiling provides this lateral support. Until the final finished ceiling is applied, temporary bracing or struts must be used.
14. If square-edge panels are used, edges must be supported between P3 Joists with 2 x 4 blocking. Glue panels to blocking to minimize squeaks. Blocking is not required under structural finish flooring such as wood strip flooring or if a separate underlayment layer is installed.
15. Nail spacing
Space the nails installed to the flange's top face in accordance with the applicable building code requirements or approved building plans.

Floor Framing and Construction Details

FIGURE 1

Typical P3 Floor Joist Framing and Construction Details

All nails shown in the details below are assumed to be common nails unless otherwise noted. Framing lumber is assumed to be Spruce-Pine-Fir. Individual components are not shown to scale for clarity.

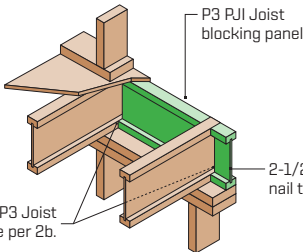
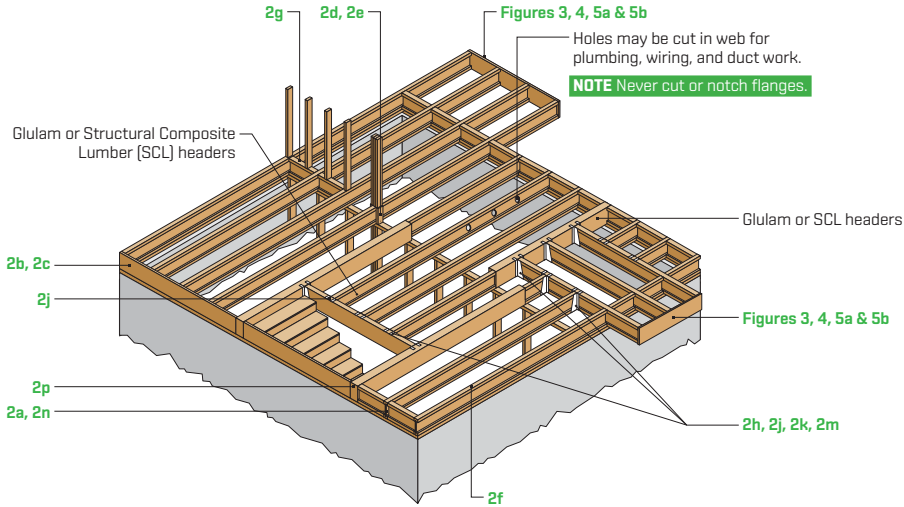

Blocking Panel or Rim Joist	Maximum Factored Uniform Vertical Load* [plf]
P3 PJI Joist (9-1/2" - 18")	3300

*The uniform vertical load capacity is limited to a joist depth of 18" or less and is based on the standard term load duration. It shall not be used in the design of a bending member such as joist, header, or rafter. For concentrated vertical load transfer capacity, see 2d.

2-1/2" nails @ 6" o.c. to top plate [When used for lateral shear transfer, nail to bearing plate with same nailing as required for decking.]

2a BLOCKING PANEL AT END SUPPORT DETAIL

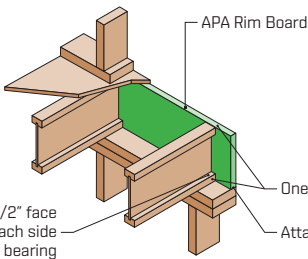

Blocking Panel or Rim Joist	Maximum Factored Uniform Vertical Load* [plf]
1-1/8" APA Rim Board Plus	8090
1-1/8" APA Rim Board	7340
1" APA Rim Board	5500

*The uniform vertical load capacity is limited to a rim board depth of 16" or less and is based on standard term load duration. It shall not be used in the design of a bending member such as joist, header, or rafter. For concentrated vertical load transfer capacity, see 2d.

One 2-1/2" nail at top and bottom flange

Attach APA Rim Board to top plate using 2-1/2" common or box toenails @ 6" o.c.

To avoid splitting flange, start nails at least 1-1/2" from end of P3 Joist. Nails may be driven at an angle to avoid splitting of bearing plate.

2b RIM BOARD DETAIL

FIGURE 1 (CONTINUED)

Typical P3 Floor Joist Framing and Construction Details

All nails shown in the details below are assumed to be common nails unless otherwise noted. Framing lumber is assumed to be Spruce-Pine-Fir. Individual components are not shown to scale for clarity.

2c P3 JOIST AS RIM JOIST DETAIL

Pair of Squash Blocks	Maximum Factored Vertical Load per Pair of Squash Blocks (lb)	
	3-1/2" wide	5-1/2" wide
2x lumber	5800	9500
1-1/8" APA Rim Board, Rim Board Plus, or Rated Sturd-I-Floor 48 oc	4500	5800
1" APA Rim Board or Rated Sturd-I-Floor 32 oc	4000	5800

Provide lateral bracing per 2a, 2b, or 2c.

2d SQUASH BLOCK DETAIL

2e LOAD TRANSFER WITH PASS THRU BLOCKING DETAIL

APA Rim Board may be used in lieu of P3 Joist. Backer is not required when APA Rim Board is used.

2f PARALLEL END P3 JOIST DETAIL

FIGURE 1 (CONTINUED)

Typical P3 Floor Joist Framing and Construction Details

All nails shown in the details below are assumed to be common nails unless otherwise noted. Framing lumber is assumed to be Spruce-Pine-Fir. Individual components are not shown to scale for clarity.

2g **BLOCKING PANEL AT INTERIOR SUPPORT DETAIL**

2h **P3 JOIST WITH BACKER BLOCKS FOR HANGER DETAIL**

BACKER BLOCK Use if factored hanger load exceeds 360 lbs. Before installing a backer block to a double P3 Joist, drive 3 additional 3" nails through the webs and filler block where the backer block will fit. Clinch. Install backer tightly to top flange. Use twelve 3" nails, clinched when possible. Maximum factored resistance for hanger for this detail is 1620 lbs.

BACKER BLOCKS Blocks must be long enough to permit required nailing without splitting.

Flange Width	Material Thickness Required*	Minimum Depth
2-1/2"	1"	5-1/2"
3-1/2"	1-1/2"	7-1/4"

* Minimum grade for backer block material shall be Utility grade SPF (south) or better for solid sawn lumber and shall be Rated Sheathing grade for wood structural panels. For face-mount hangers use net joist depth minus 3-1/4" for joists with 1-1/2" thick flanges.

For hanger capacity see hanger manufacturer's recommendations. Verify double P3 Joist capacity to support concentrated loads.

2j **P3 JOIST TO FLUSH BEAM DETAIL**

NOTE Unless hanger sides laterally support the top flange, bearing stiffeners shall be used.

FIGURE 1 (CONTINUED)

Typical P3 Floor Joist Framing and Construction Details

All nails shown in the details below are assumed to be common nails unless otherwise noted. Framing lumber is assumed to be Spruce-Pine-Fir. Individual components are not shown to scale for clarity.

2x plate flush with inside face of wall or beam

NOTE Unless hanger sides laterally support the top flange, bearing stiffeners shall be used.

Top-mounted hanger installed per manufacturer's recommendations

2k P3 JOIST WITH TOP MOUNT HANGER DETAIL

Multiple P3 Joist headers with full depth filler block is shown. Glulam and multiple SCL headers may also be used. Verify double P3 Joist capacity to support concentrated loads.

Attach backer block per 2h. Nail with twelve 3" nails. Clinch when possible

Install hanger per manufacturer's recommendations.

Filler block per Figure 2p

Maximum support capacity is 1620 lbs.

2m STAIR STRINGER TO P3 JOIST DETAIL

Do not bevel-cut joist beyond inside face of wall.

Attach P3 Joist per 2b.

2n BEVEL-CUT P3 JOIST DETAIL

NOTE Blocking is required at bearing for lateral support. Not shown for clarity

Flange Width	Net Depth	Filler Block Size
2-1/2"	9-1/2"	2-1/8" x 6"
	11-7/8"	2-1/8" x 8"
	14"	2-1/8" x 10"
	16"	2-1/8" x 12"
3-1/2"	11-7/8"	3" x 8"
	14"	3" x 10"
	16"	3" x 12"
3-1/2"	18"	3" x 14"
	20"	3" x 16"
	22"	3" x 18"
	24"	3" x 20"

Filler block

Offset nails from opposite face by 6".

1/8" gap between top flange and filler block

NOTES

- Support back of I-Joist web during nailing to prevent damage to web/flange connection.
- Leave a 1/8" gap between top of filler block and bottom of top P3 Joist flange.
- Filler block is required between joists for full length of span.
- Nail joists together with two rows of 3" nails at 12" o.c. (clinched when possible) on each side of the double P3 Joist. Total of 4 nails per foot required. If nails can be clinched, only 2 nails per foot are required.
- The maximum load that may be applied to one side of the double joist using this detail is 860 lbs./ft.

2p DOUBLE P3 JOIST CONSTRUCTION DETAIL

Minimum Nailing Requirements for Web Stiffeners

Stiffener Size and Nailing Requirement

Joist Dept	2-1/2" Wide Flange 8d [2-1/2"] nails	3-1/2" Wide Flange 10d [3"] nails
9-1/2"	4	-
11-7/8"	4	4
14"	4	4
16"	4	4
18"	-	6
20"	-	6
22"	-	8
24"	-	8
Minimum Stiffener	1" x 2-5/16" (width)	1-1/2" x 2-5/16" (width)

1. Web stiffeners are required:

- When sides of the hangers do not laterally brace the top flange of each P3 Joist;
- When P3 Joists are designed to support concentrated loads greater than 1500 lbs. that are applied to the P3 Joist's top flange between supports. In these applications only, the gap between the web stiffener and the flange shall be at the bottom flange;
- For all engineered applications with end-reactions greater than 1500 lbs.

A design analysis must be performed for all engineered applications with end-reactions greater than 1500 lbs.

2. When used at end bearings, install web stiffeners tightly against the bottom flange of the P3 Joist. Leave a minimum 1/8" gap between the top of the stiffener and the bottom of the top flange. See Figure 2.

3. Web stiffeners may be supplied by the distributor for field installation or may be cut in the field as required.

Web Stiffener Installation Details

FIGURE 2

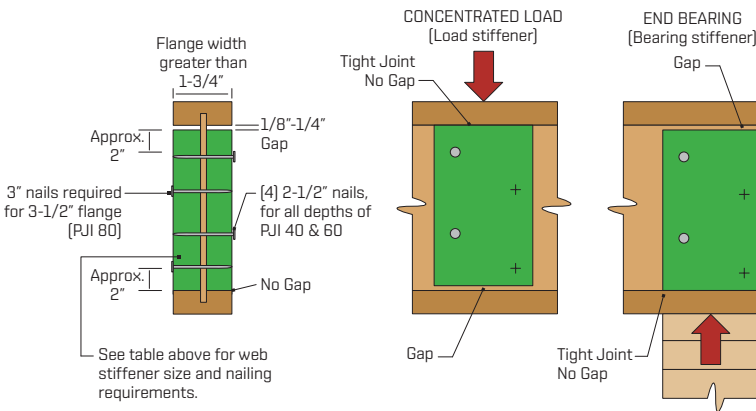

Cantilever Details for Interior Balconies (No Wall Load)

FIGURE 3

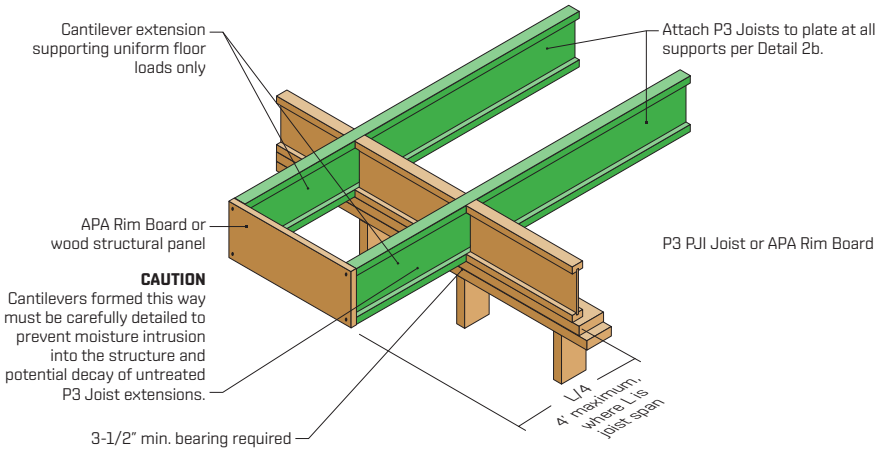

Lumber Cantilever Details For Balconies (No Wall Load)

FIGURE 4

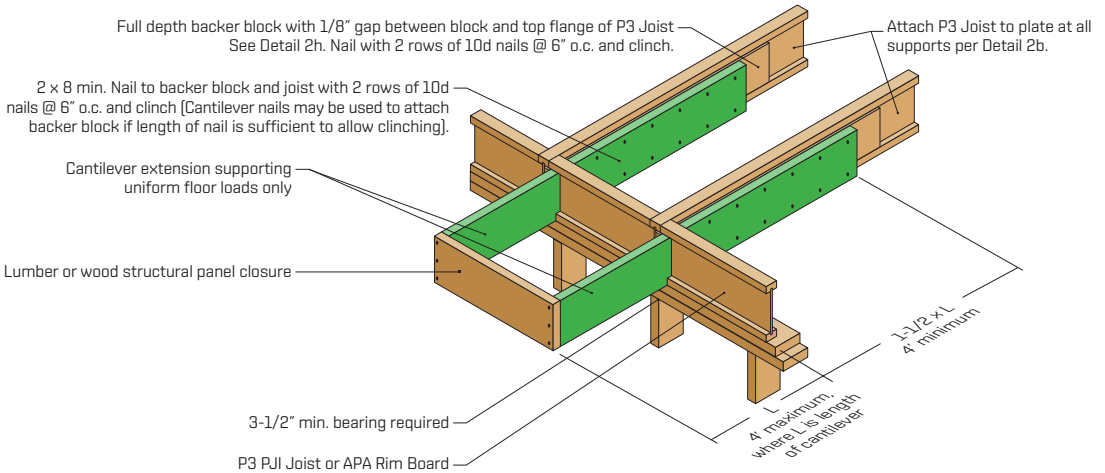

NOTES All nails shown in the details above are assumed to be common nails unless otherwise noted. Individual components are not shown to scale for clarity.

Cantilever Detail for Vertical Building Offset (Concentrated Wall Load)

FIGURE 5A

Method 1

Sheathing Reinforcement One Side

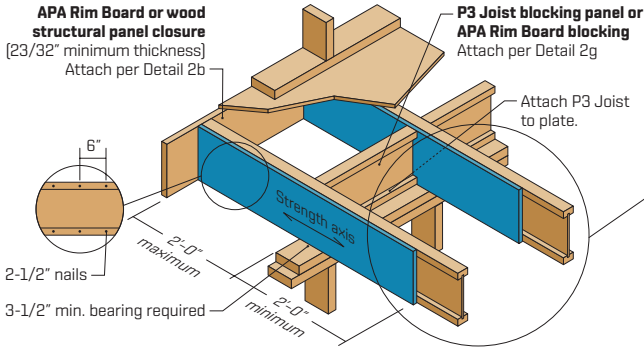

Method 2

Sheathing Reinforcement Two Sides

Use same installation as Method 1, but reinforce both sides of the P3 Joist with sheathing or APA Rim Board.

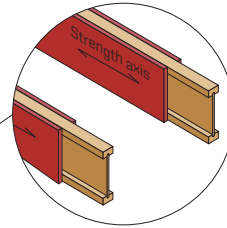

NOTE APA RATED SHEATHING 48/24 (minimum thickness 23/32") required on sides of joist. Depth shall match the full height of the joist. Nail top and bottom flange with 2-1/2" nails at 6" o.c. Install with face grain running horizontally. Attach P3 Joist to plate at all supports per Detail 2b.

FIGURE 5B

Double P3 Joists

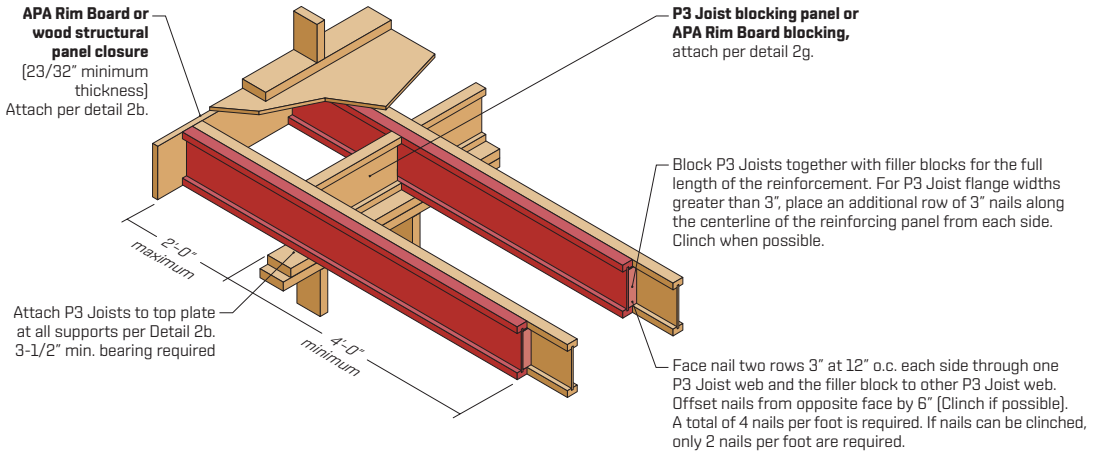

NOTES All nails shown in the details above are assumed to be common nails unless otherwise noted. Individual components are not shown to scale for clarity.

P3 Joist Typical Holes

FIGURE 6

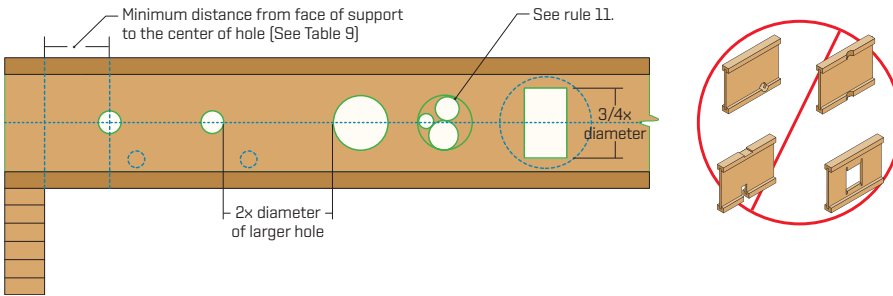

Cutting the Holes

- **Never** drill, cut, or notch the flange. **Never** over-cut the web.
- Holes in webs should be cut with a sharp saw.
- For rectangular holes avoid over cutting the corners as this can cause unnecessary stress concentrations. Slightly rounding the corners is recommended. Starting the rectangular hole by drilling a 1" diameter hole in each of the 4 corners and then making the cuts between the holes is another good method to minimize damage to I-Joist.

TABLE 7

Location Of Circular Holes In P3 Joist Webs

Simple or Multiple Span for Dead Loads up to 15 psf and Live Loads up to 40 psf^{1,2,3,4}

Joist Depth	Joist	Minimum Distance from Inside Face of Any Support to Center of Hole (ft.-in.)															
		Round Hole Diameter [in.]															
		SAF ⁽⁵⁾	2	3	4	5	6	6-1/4	7	8	8-5/8	9	10	10-3/4	11	12	12-3/4
9-1/2"	PJI 40	14'-3"	0'-8"	1'-10"	3'-2"	4'-6"	5'-11"	6'-4"									
	PJI 60	14'-9"	1'-5"	2'-8"	4'-0"	5'-5"	6'-11"	7'-3"									
11-7/8"	PJI 40	16'-0"	0'-7"	0'-8"	1'-5"	2'-8"	4'-0"	4'-4"	5'-5"	6'-11"	7'-11"						
	PJI 60	16'-6"	0'-7"	0'-10"	2'-1"	3'-5"	4'-9"	5'-1"	6'-2"	7'-8"	8'-8"						
	PJI 80	17'-5"	0'-7"	1'-8"	2'-11"	4'-3"	5'-7"	5'-11"	7'-0"	8'-7"	9'-8"						
14"	PJI 40	17'-5"	0'-7"	0'-8"	0'-8"	0'-11"	2'-2"	2'-6"	3'-6"	4'-10"	5'-9"	6'-3"	7'-10"	9'-1"			
	PJI 60	17'-11"	0'-7"	0'-8"	0'-8"	1'-9"	3'-0"	3'-4"	4'-4"	5'-9"	6'-8"	7'-3"	8'-10"	10'-1"			
	PJI 80	19'-2"	0'-7"	0'-8"	1'-4"	2'-7"	3'-11"	4'-3"	5'-4"	6'-9"	7'-8"	8'-3"	9'-10"	11'-2"			
16"	PJI 40	18'-9"	0'-7"	0'-8"	0'-8"	0'-9"	0'-9"	0'-10"	1'-9"	3'-0"	3'-10"	4'-4"	5'-9"	6'-10"	7'-3"	8'-10"	10'-1"
	PJI 60	19'-6"	0'-7"	0'-8"	0'-8"	0'-9"	1'-6"	1'-10"	2'-10"	4'-2"	5'-0"	5'-6"	6'-11"	8'-1"	8'-6"	10'-1"	11'-5"
	PJI 80	20'-10"	0'-7"	0'-8"	0'-8"	1'-3"	2'-6"	2'-10"	3'-10"	5'-2"	6'-0"	6'-7"	8'-0"	9'-2"	9'-7"	11'-3"	12'-7"
18"	PJI 80	22'-5"	0'-7"	0'-8"	0'-8"	0'-9"	0'-9"	0'-10"	0'-10"	2'-3"	3'-1"	3'-8"	5'-2"	6'-3"	6'-8"	8'-3"	9'-7"
20"	PJI 80	23'-11"	0'-7"	0'-8"	0'-8"	0'-9"	0'-9"	0'-10"	0'-10"	1'-9"	2'-6"	3'-1"	4'-5"	5'-5"	5'-9"	7'-3"	8'-4"
22"	PJI 80	25'-4"	0'-7"	0'-8"	0'-8"	0'-9"	0'-9"	0'-10"	0'-10"	1'-3"	2'-0"	2'-5"	3'-9"	4'-8"	5'-0"	6'-4"	7'-4"
24"	PJI 80	26'-9"	0'-7"	0'-8"	0'-8"	0'-9"	0'-9"	0'-10"	0'-10"	0'-10"	1'-7"	2'-0"	3'-2"	4'-1"	4'-4"	5'-7"	6'-6"

NOTES

1. Above tables may be used for P3 Joist spacing of 24" on center or less.
2. Hole location distance is measured from inside face of supports to center of hole.
3. Distances in this chart are based on uniformly loaded joists.
4. Hole sizes and/or locations that fall outside of the scope of this table may be acceptable based on analysis of actual hole size, span, spacing, and loading conditions.
5. SAF stands for Span Adjustment Factor. SAF is used as defined below.

OPTIONAL

Table 9 is based on the P3 Joist being used at their maximum span. If the P3 Joist are placed at less than their full allowable span, the maximum distance from the centerline of the hole to the face of any support [D] as given above may be reduced as follows.

$$D_{\text{reduced}} = \frac{L_{\text{actual}}}{\text{SAF}} \times D$$

Where: D_{reduced} = Distance from the inside face of any support to center of hole is reduced for less-than-maximum span applications (ft). The reduced distance shall not be less than 6" from the face of support to edge of the hole.

L_{actual} = The actual measured span distance between the inside faces of supports (ft)

SAF = Span Adjustment Factor is given in the table above.

D = The minimum distance from the inside face of any support to center of hole from Table 9 above

If $\frac{L_{\text{actual}}}{\text{SAF}}$ is greater than 1, use 1 in the above calculation for L_{actual}

Typical P3 Joist Roof Framing and Construction Details

FIGURE 7

All nails shown in the details below are assumed to be common nails unless otherwise noted. Framing lumber is assumed to be Spruce-Pine-Fir. Individual components are not shown to scale for clarity.

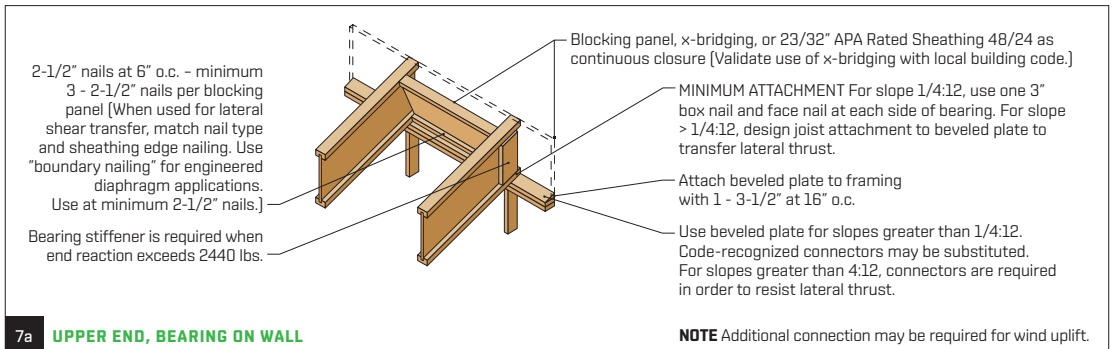
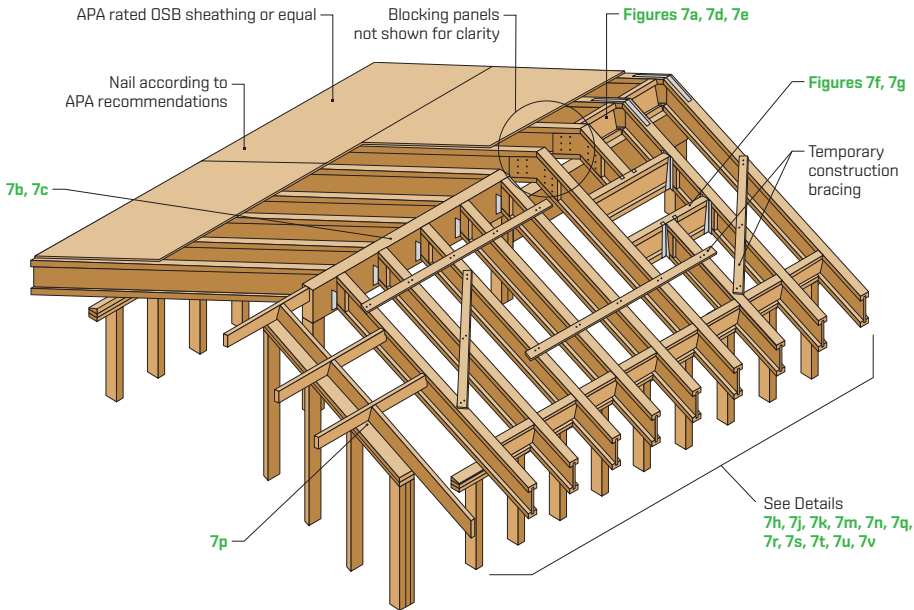

FIGURE 7 (CONTINUED)

Typical P3 Joist Roof Framing and Construction Details

All nails shown in the details below are assumed to be common nails unless otherwise noted. Framing lumber is assumed to be Spruce-Pine-Fir. Individual components are not shown to scale for clarity.

Beveled bearing stiffener required each side

For roof slopes between 1/4:12 and 12:12, provide a strap tie nailed at a minimum of 3" spacing or in accordance with the recommendation of the strap manufacturer.

Ridge beam (Glulam or LVL)

Adjustable Slope Hanger with a minimum factored uplift resistance of 450 lbs.

7b PEAK CONNECTION

NOTE Additional connection may be required for wind uplift.

Adjustable Slope Hanger with a minimum uplift resistance of 450 lbs.

Beveled bearing stiffener required each side

For roof slopes between 1/4:12 and 12:12, provide a strap nailed at a minimum of 3" spacing on each side of roof slope or in accordance with the recommendation of the strap manufacturer.

Ridge beam (Glulam or LVL)

7c P3 JOIST TO RIDGE BEAM CONNECTION

NOTE Additional connection may be required for wind uplift.

Blocking panel or x-bridging Attach per 7a

Support beam or wall

24"

23/32" x 2'-0" wood structural panel (front and back sides) with 12 - 2-1/2" nails into each joist with nails clinched (When roof live load exceeds 40 psf, horizontal orientation of gusset strong axis is required. Include a gap of 1/8" at top.)

Attach per 7a

Attach beveled plate to framing with 1 - 3-1/2" at 16" o.c.

7d P3 JOIST CONNECTION WITH WOOD STRUCTURAL PANEL GUSSETS

NOTE Additional connection may be required for wind uplift.

Tie strap nailed at a minimum of 3" spacing or in accordance with manufacturer's recommendations

Beveled bearing plate

STRAP NAILS Leave 2-3/8" minimum end distance

7e P3 JOIST CONNECTION WITH TIE STRAP

NOTE Additional connection may be required for wind uplift.

FIGURE 7 (CONTINUED)

Typical P3 Joist Roof Framing and Construction Details

All nails shown in the details below are assumed to be common nails unless otherwise noted. Framing lumber is assumed to be Spruce-Pine-Fir. Individual components are not shown to scale for clarity.

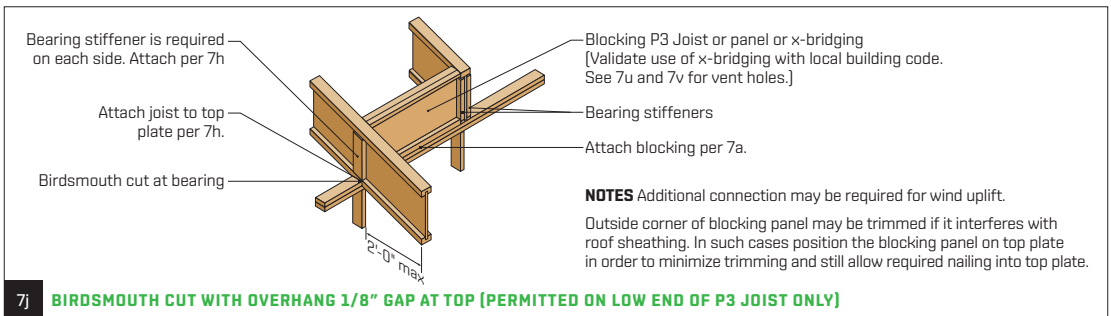
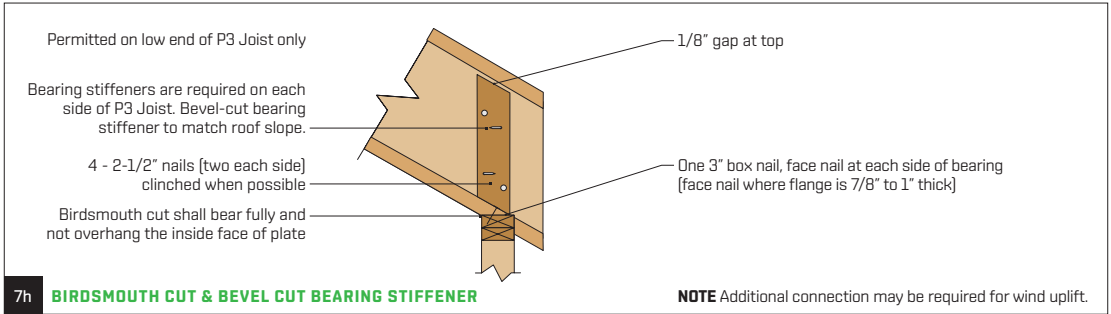
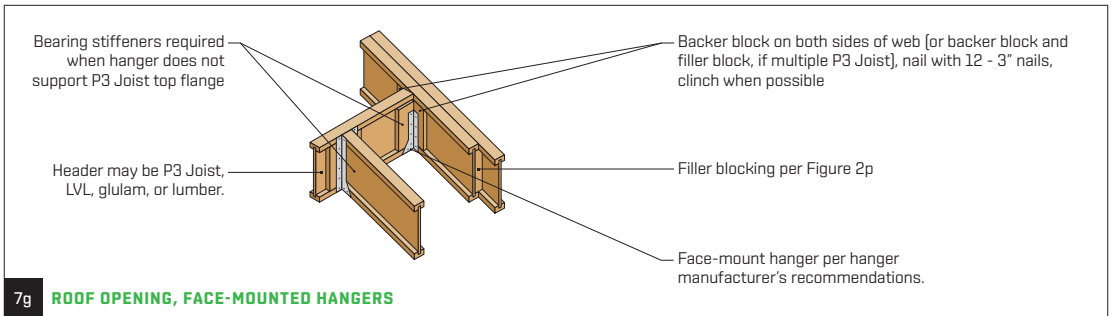
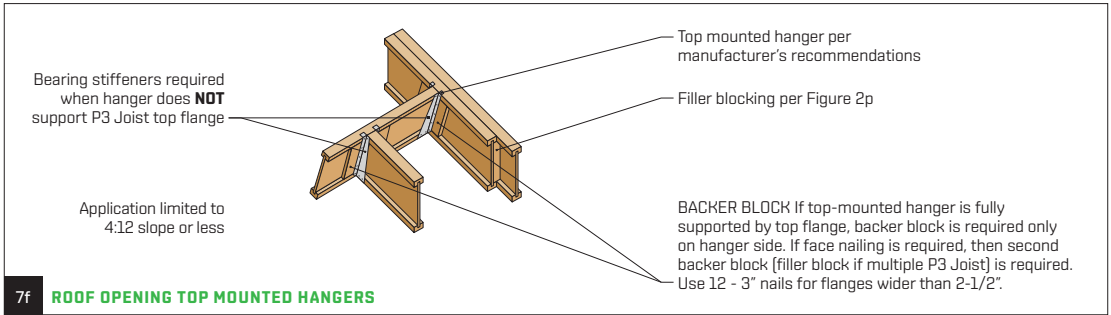

FIGURE 7 (CONTINUED)

Typical P3 Joist Roof Framing and Construction Details

All nails shown in the details below are assumed to be common nails unless otherwise noted. Framing lumber is assumed to be Spruce-Pine-Fir. Individual components are not shown to scale for clarity.

7k P3 JOIST OVERHANG FOR FASCIA SUPPORT WITH BIRDSMOUTH CUT

Birdsmouth cut at bearing
Attach P3 Joist to top plate per 7h.
2'-0" max
X-bridging or blocking panel
Validate use of X-bridging with local building code.
Web stiffener required each side
2x block for fascia support

7m BLOCKING PANEL AT BEVELED PLATE

Overhang
2'-0" max
Blocking Panel Attach per 7a (See 7u and 7v for vent holes.)
Attach P3 Joist to beveled plate per 7a.
Attach P3 Joist per 7a.
Beveled plate

NOTE Additional connection may be required for wind uplift.

7n P3 JOIST WITH BEVEL-CUT END

Do not bevel-cut joist beyond inside face of wall.
Attach P3 Joist per 7a.

NOTE Blocking or x-bridging is required at bearing for lateral support. Not shown for clarity. Additional connection may be required for wind uplift.

7p OUTRIGGER

Notch 2x outrigger around P3 Joist flange.
Blocking between outriggers
End wall
Do not notch P3 Joist flange.
Maximum overhang same as rafter spacing (not to exceed 2'-0")
Toe nail blocking to end wall for roof sheathing 5/8". Match nail type and spacing with roof sheathing edge nailing. ("Boundary nailing" for engineered diaphragm applications) Use minimum 2-1/2" nails.

NOTE Additional connection may be required for wind uplift.

7q P3 JOIST OVERHANG WITH BEVELED PLATE

Attach per 7a
2'-0" max
Blocking panels are attached per 7a or x-bridging. Validate use of x-bridging with local building code.

NOTE Additional connection may be required for wind uplift.

FIGURE 7 (CONTINUED)

Typical P3 Joist Roof Framing and Construction Details

All nails shown in the details below are assumed to be common nails unless otherwise noted. Framing lumber is assumed to be Spruce-Pine-Fir. Individual components are not shown to scale for clarity.

7r LUMBER OVERHANG WITH BEVELED PLATE

Blocking panel or x-bridging not shown for clarity

NOTE Additional connection may be required for wind uplift. Lumber overhang shall be 2x4 Spruce-Pine-Fir #2 or better or a stronger species.

7s P3 JOIST OVERHANG FOR FASCIA SUPPORT WITH BIRDSMOUTH CUT

NOTE Additional connection may be required for wind uplift.

7t P3 JOIST OVERHANG FOR FASCIA SUPPORT WITH BEVELED PLATE

NOTE Additional connection may be required for wind uplift.

7u BIRDSMOUTH CUT ALLOWED AT LOW END OF P3 JOIST ONLY

NOTE Corrosion-resistant wire cloth screening, hardware cloth, perforated vinyl, or similar material shall cover the ventilation holes per code.

P3 Products Warranty

Limited Lifetime Warranty

EACOM Timber Corporation warrants that its line of P3 Products are free from defects in design, materials and workmanship. When installed and finished according to our published installation instructions and accepted engineering standards, our P3 Products will perform in accordance with our current published specifications for the lifetime of your home or building.

Warranty Limitations

EACOM Timber Corporation must be given a reasonable opportunity to inspect the product before it will honor any claims under this warranty. If after inspection and verification of the problem, we determine that there is a structural failure covered by the warranty, we will pay to the owner of the structure an amount of money equal to the reasonable cost of the defective product, or, at our option, replace any defective product. This warranty does not cover the cost of installation, removal of the defective product, or reinstallation of replacement product. Checks, cracks or splits of P3 Products resulting from the natural physical properties of wood are not covered — unless the condition causes a structural weakness.

Please protect your investment! P3 Products must be protected from exposure to moisture from whatever source by proper building standards. Exposure to moisture beyond incidental exposure during normal construction periods may cause product failure and will void this limited warranty.

This warranty shall apply only if the P3 Product is subjected to normal use and exposure. The products must be stored, handled, and installed in a manner generally accepted in the industry, and in accordance with our current published installation instructions and in compliance with our product design specifications relating to spans and loading. Failure to follow such instructions will void this warranty.

Disclaimer

EXCEPT FOR THE EXPRESS WARRANTY AND REMEDY SET FORTH ABOVE, EACOM TIMBER CORPORATION DISCLAIMS ALL OTHER WARRANTIES AND GUARANTEES, EXPRESS OR IMPLIED, INCLUDING IMPLIED WARRANTIES OF MERCHANTABILITY OR FITNESS FOR A PARTICULAR PURPOSE. No other warranty or guarantee will be made by or on behalf of the manufacturer or the seller or by operation of law with respect to the product or its installation, storage, handling, maintenance, use, replacement, or repair. Neither EACOM Timber Corporation nor the seller shall be liable by virtue of any warranty or guarantee, or otherwise, for any special or incidental or consequential loss or damage resulting from the use of the product. EACOM Timber Corporation makes no warranty or guarantee with respect to installation of the product by the builder or the builder's contractor or by any other installer.

This warranty gives you specific legal rights and you may also have other rights which vary from state to state.

For information on our P3 Products or our warranty, contact us at:

EACOM Timber Corporation
1100 René Lévesque Blvd. West, Suite 2110
Montreal, Québec H3B 4N4
www.eacom.ca

Sales Contact:

Jeff Kilgour
EACOM Timber Corporation
1100 René Lévesque Blvd. West, Suite 2110
Montreal, Québec H3B 4N4
www.eacom.ca
P3sales@eacom.ca

Plant:

EACOM Timber Corporation
1195 Peoples Road
Sault Ste. Marie, Ontario
Canada P6C 3W7

Distributed by: