

---

**P3 JOIST**

---

**INSTALLATION**

---

**GUIDE**

---

**US 2018**

---

BY  **EACOM**  
TIMBER CORPORATION

---

# P3 JOIST

## Storage and Handling Guidelines

1. Store, stack, and handle P3 Joists in a vertical and level position only.
2. Do not store P3 Joists in direct contact with the ground; do not store P3 Joist flatwise.
3. Protect P3 Joists from weather, and use stickers to separate bundles.
4. To protect P3 Joists further from dirt and weather, do not open bundles until time of installation.
5. When lifting P3 Joists with a crane on the job site, take a few simple precautions to prevent damage to the P3 Joists and to prevent injury to your work crew.
  - Lift P3 Joists in bundles as shipped by the supplier.
  - Orient the bundles so that the webs of the P3 Joists are vertical.
  - Lift the bundles at the 5th points, using a spreader bar if necessary.
6. Do not twist or apply loads to the P3 Joists when horizontal.
7. Never use or try to repair a damaged P3 Joists.

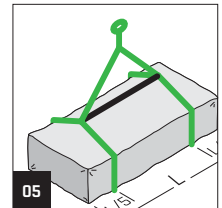
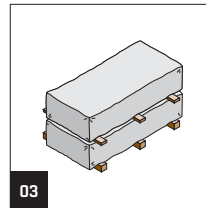
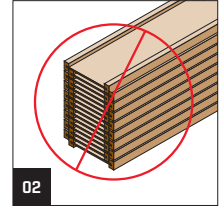
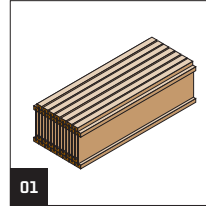

## Safety Precautions

**WARNING** P3 Joists are not stable until completely installed and will not carry any load until fully braced and sheathed.

### Avoid Accidents by Following These Important Guidelines.

1. Brace and nail each P3 Joist as it is installed, using hangers, blocking panels, rim board, and/or cross-bridging at joist ends. When P3 Joists are applied continuously over interior supports and a load-bearing wall is planned at the location, blocking will be required at the interior supports.
  - Temporary bracing or struts must be 1 x 4" minimum, at least 8' long, spaced no more than 8' on center, and secured with a minimum of two 8d nails fastened to the top surface of each P3 Joist. Nail bracing to a lateral restraint at the end of each bay. Lap ends of adjoining bracing over at least two P3 Joists.
  - Or, sheathing [temporary or permanent] can be nailed to the top flange of the first 4' of the P3 Joist at the end of the bay.
3. For cantilevered P3 Joists, brace top and bottom flanges, and brace ends with closure panels, rim board, or cross-bridging.
4. Install and nail permanent sheathing to each P3 Joist before placing loads on the floor system. Then, stack building materials over beams or walls only.
5. For temporary construction loads such as dry wall stacking, see APA Publication J735A [Temporary Construction Loads Over I-Joist Roofs].

Failure to follow applicable building codes and span ratings, failure to use allowable hole sizes and locations, or failure to use web stiffeners when required can result in serious accidents. Follow these installation guidelines carefully.

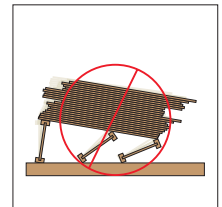
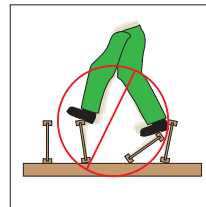

# Allowable Floor Spans

## Maximum Allowable Spans

The specific PJI designation needed for your application is easily determined by selecting the span needed and then by choosing the PJI that meets your span, spacing, and uniform loading criteria.

Tables 1 and 1a are for simple or multiple span applications respectively. The use of these tables will provide maximum spans for the indicated spacing and span conditions.

To illustrate the selection of a P3 Joist product, assume a design simple span of 16'-1". For architectural reasons limit the joist depth to 11-7/8" and joist spacing to 19.2" on center. From the 9-1/2" and 11-7/8" entries in Table 1, look down the 19.2" o.c. spacing column. For depths of 9-1/2", select 9-1/2" PJI 60, and from the 11-7/8" depths, notice that any joist designation will work.

The allowable spans in the tables in this user guide indicate the allowable clear span for various joist spacings under typical residential uniform floor loads (40 psf live load and 10 psf dead load) for glued-nailed systems.

In addition, floor sheathing must be field glued to the P3 Joist flanges using approved construction adhesives in order to achieve the P3 Joist allowable spans.

Use of these span tables is limited to uniform load conditions, and P3 floor Joist spans shall not exceed these allowable spans. P3 Joist can be used for other applications such as roofs and ceilings to support line loads or concentrated loads, etc., when properly engineered, using the appropriate design properties in Tables 19 and 20 of the user guide.

### NOTES

1. Allowable clear span is applicable to simple-span or multiple-span residential floor construction with a design dead load of 10 psf and a live load of 40 psf. The live load deflection is limited to L/480. (L = span length in inches). Spans are based on duration factor (LDF) of 1.0.
2. Spans are based on a composite floor with glue-nailed sheathing meeting the requirements for APA Rated Sheathing STURD-I-FLOOR conforming to PS1 or PS2 with a minimum thickness of 19/32" (40/20 or 20 o.c.) for a joist spacing of 19.2" or less or with a minimum thickness of 23/32" (48/24 or 24 o.c.) for a joist spacing of 24" when floor sheathing is nailed only. Adhesive shall meet APA Specification AFG-01 or ASTM D3498. Spans shall be reduced to 12" when floor sheathing is nailed only.
3. Minimum bearing length shall be 1-3/4" for the end bearings and 3-1/2" for the intermediate bearings.
4. Bearing or web stiffeners are required for all PJI Joist in the span tables if over 16" deep.

**TABLE 1 - LDF = 1.0**

### Allowable Spans for P3 Floor Joist

Simple span only - Glued subfloor\* - On center spacing

Maximum floor span (ft)			Glued subfloor				
Load		Series	Depth (in)	On center joist spacing (in)			
Live	Dead			12	16	19.2	24
40	10	PJI 40	9-1/2	18'-0"	16'-5"	15'-6"	14'-6"
			11-7/8	21'-5"	19'-7"	18'-6"	16'-8"
			14	24'-4"	22'-3"	20'-6"	18'-4"
			16	26'-11"	24'-3"	22'-1"	19'-9"
		PJI 60	9-1/2	18'-11"	17'-4"	16'-4"	15'-3"
			11-7/8	22'-7"	20'-8"	19'-6"	18'-2"
			14	25'-9"	23'-6"	22'-2"	20'-8"
			16	28'-6"	26'-0"	24'-7"	22'-10"
		PJI 80	11-7/8	24'-11"	22'-8"	21'-4"	19'-10"
			14	28'-3"	25'-9"	24'-3"	22'-7"
			16	31'-4"	28'-6"	26'-10"	25'-0"
			18	34'-2"	31'-1"	29'-3"	27'-3"
	20		36'-11"	33'-8"	31'-8"	29'-6"	
	22		39'-8"	36'-1"	34'-0"	31'-8"	
	24		42'-4"	38'-6"	36'-4"	33'-9"	
	PJI 90		11-7/8	25'-7"	23'-3"	21'-11"	20'-5"
		14	29'-0"	26'-5"	24'-11"	23'-2"	
		16	32'-1"	29'-3"	27'-6"	25'-5"	
		18	35'-1"	31'-11"	30'-1"	27'-11"	
		20	37'-11"	34'-6"	32'-6"	30'-3"	
		22	40'-9"	37'-7"	34'-11"	32'-6"	
		24	43'-5"	39'-6"	37'-3"	34'-8"	

\*For other type floor assemblies, please contact EACOM at [www.eacom.com](http://www.eacom.com).

SI: 1 inch = 25.4 mm, 1 foot = 304.8 mm, 1psf = 47.88 Pa

**TABLE 1 A - LDF = 1.0**

### Allowable Spans for P3 Floor Joist

Multiple span only - Glued subfloor\* - On center spacing

Maximum floor span (ft)			Glued subfloor				
Load		Series	Depth (in)	On center joist spacing (in)			
Live	Dead			12	16	19.2	24
40	10	PJI 40	9-1/2	19'-7"	17'-11"	16'-4"	14'-7"
			11-7/8	23'-5"	20'-5"	18'-7"	16'-7"
			14	25'-11"	22'-5"	20'-5"	18'-3"
			16	27'-11"	24'-2"	22'-0"	19'-8"
		PJI 60	9-1/2	20'-8"	18'-10"	17'-9"	16'-6"
			11-7/8	24'-8"	22'-6"	21'-2"	19'-7"
			14	28'-0"	25'-7"	24'-1"	19'-9"
			16	31'-1"	28'-4"	24'-9"	19'-9"
		PJI 80	11-7/8	27'-1"	24'-8"	23'-3"	21'-7"
			14	30'-10"	28'-0"	26'-5"	23'-11"
			16	34'-2"	31'-1"	29'-3"	23'-11"
			18	37'-3"	33'-10"	31'-11"	29'-5"
	20		40'-3"	36'-8"	34'-6"	31'-0"	
	22		43'-3"	39'-4"	36'-4"	31'-5"	
	24		46'-2"	41'-6"	37'-10"	31'-5"	
	PJI 90		11-7/8	27'-11"	25'-4"	23'-10"	21'-10"
		14	31'-8"	28'-9"	27'-1"	23'-11"	
		16	35'-0"	31'-10"	29'-11"	25'-11"	
		18	38'-3"	34'-9"	32'-9"	30'-5"	
		20	41'-5"	37'-8"	35'-5"	31'-5"	
		22	44'-5"	40'-5"	38'-0"	31'-5"	
		24	47'-5"	43'-1"	39'-3"	31'-5"	

# Web Stiffener Requirements

## Minimum Nailing Requirements for Web Stiffeners

### Stiffener Size and Nailing Requirement

Joist Dept	2-1/2" Wide Flange 8d [2-1/2"] nails	3-1/2" Wide Flange 10d [3"] nails
9-1/2"	4	-
11-7/8"	4	4
14"	4	4
16"	4	4
18"	-	6
20"	-	6
22"	-	8
24"	-	8
Minimum Stiffener	1" x 2-5/16" (width)	1-1/2" x 2-5/16" (width)

#### 1. Web stiffeners are required:

- When sides of the hangers do not laterally brace the top flange of each P3 Joist;
- When P3 Joists are designed to support concentrated loads greater than 1580 lbs. that are applied to the P3 Joists top flange between supports. In these applications only, the gap between the web stiffener and the flange shall be at the bottom flange;
- For all engineered applications with end-reactions greater than 1580 lbs.  
**A design analysis must be performed for all engineered applications with end-reactions greater than 1580 lbs.**

#### 2. When used at end bearings, install web stiffeners tightly against the bottom flange of the P3 Joist. Leave a minimum 1/8" gap between the top of the stiffener and the bottom of the top flange. See Figure 1.

#### 3. Web stiffeners may be supplied by the distributor for field installation or may be cut in the field as required.

## Web Stiffener Installation Details

FIGURE 1

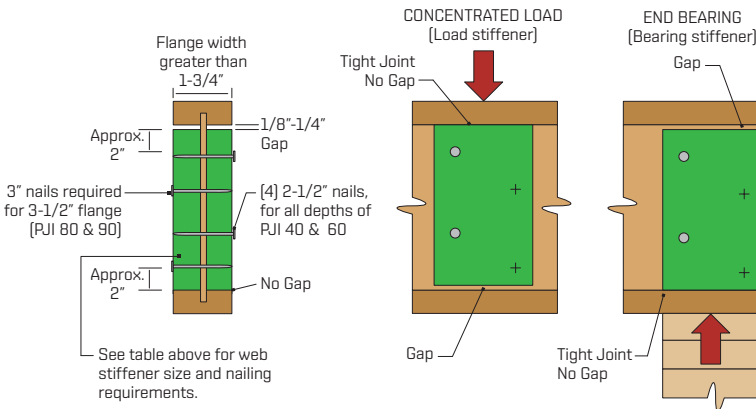

# Installing P3 Joist

1. Before laying out floor system components, verify that P3 Joist flange widths match hanger widths. If not, contact your supplier.
2. Except for cutting to length, never cut, drill, or notch P3 Joist flanges.
3. Install P3 Joists so that top and bottom flanges are within 1/2" of true vertical alignment.
4. P3 Joists must be anchored securely to supports before floor sheathing is attached, and supports for multiple-span joists must be level.
5. Minimum bearing lengths are 1-3/4" for end bearings and 3-1/2" for intermediate bearings.
6. When using hangers, seat P3 Joist firmly in hanger bottoms to minimize settlement.
7. Leave a 1/16" gap between the P3 Joist end and a header.
8. Concentrated loads greater than those that can normally be expected in residential construction should be applied only to the top surface of the top flange. Normal concentrated loads include track lighting fixtures, audio equipment, and security cameras. Never suspend unusual or heavy loads from the P3 Joists bottom flange. Whenever possible, suspend all concentrated loads from the top of the P3 Joist, or attach the load to blocking that has been securely fastened to the P3 Joist webs.
9. Never install P3 Joists where they will be permanently exposed to weather or where they will remain in direct contact with concrete or masonry.
10. Restrain ends of floor joists to prevent rollover. Use Certified Rim Board, rim joists, or P3 Joist blocking panels.
11. For P3 Joists installed over and beneath bearing walls, use full depth blocking panels, Certified Rim Board, or squash blocks (cripple members) to transfer gravity loads through the floor system to the wall or foundation below.
12. Due to shrinkage, common framing lumber set on edge may never be used as blocking or rim boards. P3 Joist blocking panels or other engineered wood products such as Certified Rim Board must be cut to fit between the P3 Joists, and a P3 Joist-compatible depth must be selected.
13. Provide permanent lateral support of the bottom flange of all P3 Joists at interior supports of multiple-span joists. Similarly, support the bottom flange of all cantilevered P3 Joists at the end support next to the cantilever extension. In the completed structure, the gypsum wallboard ceiling provides this lateral support. Until the final finished ceiling is applied, temporary bracing or struts must be used.
14. If square-edge panels are used, edges must be supported between P3 Joists with 2 x 4 blocking. Glue panels to blocking to minimize squeaks. Blocking is not required under structural finish flooring such as wood strip flooring or if a separate underlayment layer is installed.
15. Nail spacing  
Space the nails installed to the flange's top face in accordance with the applicable building code requirements or approved building plans.

# Floor Framing and Construction Details

**FIGURE 2**  
**Typical P3 Floor Joist Framing and Construction Details**

All nails shown in the details below are assumed to be common nails unless otherwise noted. 10d box nails [0.128 x 3"] may be substituted for 8d common [0.131 x 2-1/2"] as shown in details. Individual components are not shown to scale for clarity.

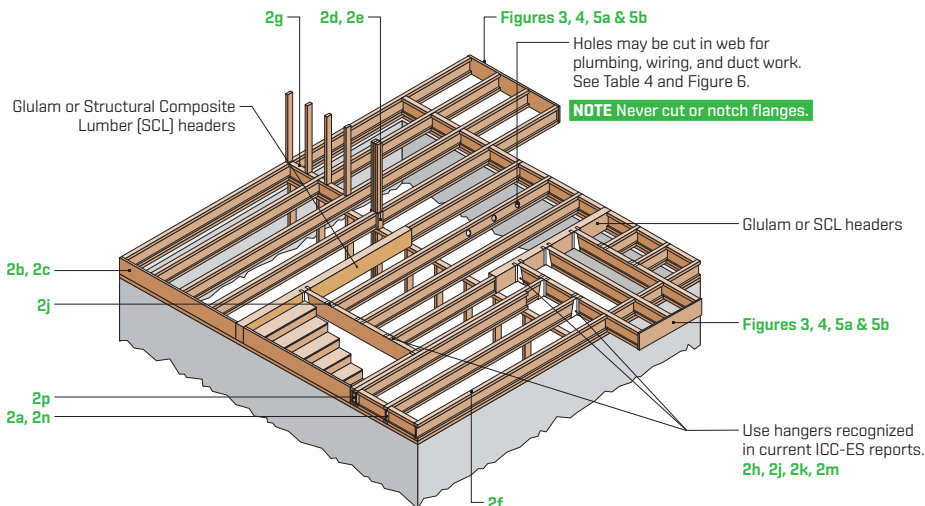

**FIGURE 2 (CONTINUED)**

**Typical P3 Floor Joist Framing and Construction Details**

All nails shown in the details below are assumed to be common nails unless otherwise noted. 10d box nails [0.128 x 3"] may be substituted for 8d common [0.131 x 2-1/2"] as shown in details. Individual components are not shown to scale for clarity.

Blocking Panel or Rim Joist	Uniform Vertical Load Transfer Capacity* [plf]
P3 Joist [9 1/2" - 18"]	2000

\*The uniform vertical load capacity is limited to a joist depth of 18" or less and is based on the normal [10-yr] load duration. It shall not be used in the design of a bending member such as joist, header, or rafter. For concentrated vertical load transfer capacity, see 2d.

8d nails @ 6" o.c. to top plate (when used for lateral shear transfer, nail to bearing plate with same nailing as required for decking)

2a **BLOCKING PANEL AT END SUPPORT DETAIL**

Blocking Panel or Rim Joist	Uniform Vertical Load Transfer Capacity* [plf]
1-1/8" APA Rim Board Plus	4850
1-1/8" APA Rim Board	4400
1" APA Rim Board	3300

\*The uniform vertical load capacity is limited to Rim Board depth of 18" or less and is based on the normal [10-yr] load duration. It shall not be used in the design of a bending member such as joist, header, or rafter. For concentrated vertical load transfer capacity, see 2d.

One 8d common or box nail at top and bottom flange

To avoid splitting flange, start nails at least 1-1/2" from end of P3 Joist. Nails may be driven at an angle to avoid splitting of bearing plate.

2b **RIM BOARD DETAIL**

2c **P3 JOIST AS RIM JOIST DETAIL**

Pair of Squash Blocks	Vertical load transfer capacity per pair of squash blocks [lb]	
	3-1/2" wide	5-1/2" wide
2x lumber	3800	5900
1-1/8" APA Rim Board, Rim Board Plus, or Rated Sturd-I-Floor 48 oc	2600	4000
1" APA Rim Board or Rated Sturd-I-Floor 32 oc	1900	3000

Provide lateral bracing per 2a, 2b, or 2c.

2d **SQUASH BLOCK DETAIL**

**FIGURE 2 (CONTINUED)**

**Typical P3 Floor Joist Framing and Construction Details**

All nails shown in the details below are assumed to be common nails unless otherwise noted. 10d box nails [0.128 x 3"] may be substituted for 8d common [0.131 x 2-1/2"] as shown in details. Individual components are not shown to scale for clarity.

**2e** **LOAD TRANSFER WITH PASS THRU BLOCKING DETAIL**

**2f** **PARALLEL END P3 JOIST DETAIL**

APA Rim Board may be used in lieu of P3 Joist. Backer is not required when APA Rim Board is used.

**2g** **BLOCKING PANEL AT INTERIOR SUPPORT DETAIL**

Blocking required over all interior supports under load-bearing walls or when floor joists are not continuous over support. In high seismic areas (SDC 00, D1 and D2) the IRC requires blocking at all intermediate supports. The IBC requires blocking at all supports for all Seismic Design Categories.

**2h** **P3 JOIST WITH BACKER BLOCKS FOR HANGER DETAIL**

**BACKER BLOCK** Use if hanger load exceeds 250 lbs. Before installing a backer block to a double P3 Joist, drive 3 additional 10d nails through the webs and filler block where the backer block will fit. Clinch. Install backer tightly to top flange. Use twelve 10d nails, clinched when possible. Maximum capacity for hanger for this detail is 1280 lbs.

**BACKER BLOCKS** Blocks must be long enough to permit required nailing without splitting.

Flange Width	Material Thickness Required*	Minimum Depth**
2-1/2"	1"	5-1/2"
3-1/2"	1-1/2"	7-1/4"

\* Minimum grade for backer block material shall be Utility grade SPF (south) or better for solid sawn lumber and shall be Rated Sheathing grade for wood structural panels.  
 \*\* For face-mount hangers, use net joist depth minus 3-1/4" for joists with 1-1/2" thick flanges.

For hanger capacity see hanger manufacturer's recommendations. Verify double P3 Joist capacity to support concentrated loads.

**FIGURE 2 (CONTINUED)**

**Typical P3 Floor Joist Framing and Construction Details**

All nails shown in the details below are assumed to be common nails unless otherwise noted. 10d box nails (0.128 x 3") may be substituted for 8d common (0.131 x 2-1/2") as shown in details. Individual components are not shown to scale for clarity.

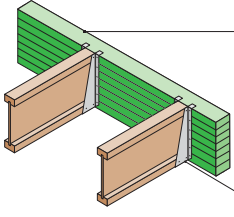

Glulam or multiple structural composite lumber (SCL) beams

For nailing schedules for multiple SCL beams, see the manufacturer's recommendations.

Top- or face-mounted hanger installed per manufacturer's recommendations

**2j** **P3 JOIST TO FLUSH BEAM DETAIL**

**NOTE** Unless hanger sides laterally support the top flange, bearing stiffeners shall be used.

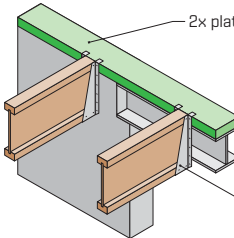

2x plate flush with inside face of wall or beam

**NOTE** Unless hanger sides laterally support the top flange, bearing stiffeners shall be used.

Top-mounted hanger installed per manufacturer's recommendations

**2k** **P3 JOIST WITH TOP MOUNT HANGER DETAIL**

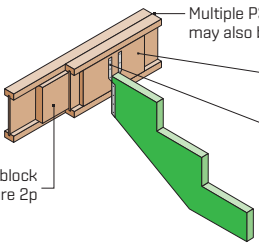

Multiple P3 Joist headers with full depth filler block is shown. Glulam and multiple SCL headers may also be used. Verify double P3 Joist capacity to support concentrated loads.

Attach backer block per 1h. Nail with twelve 10d nails. Clinch when possible

Install hanger per manufacturer's recommendations.

Maximum support capacity is 1280 lbs.

Filler block per Figure 2p

**2m** **STAIR STRINGER TO P3 JOIST DETAIL**

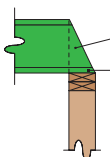

Do not bevel-cut joist beyond inside face of wall.

Attach P3 Joist per 2b.

**2n** **BEVEL-CUT P3 JOIST DETAIL**

**NOTE** Blocking is required at bearing for lateral support. Not shown for clarity



**FIGURE 2 (CONTINUED)**

**Typical P3 Floor Joist Framing and Construction Details**

All nails shown in the details below are assumed to be common nails unless otherwise noted. 10d box nails (0.128 x 3") may be substituted for 8d common (0.131 x 2-1/2") as shown in details. Individual components are not shown to scale for clarity.

Flange Width	Net Depth	Filler Block Size
2-1/2"	9-1/2"	2-1/8" x 6"
	11-7/8"	2-1/8" x 8"
	14"	2-1/8" x 10"
	16"	2-1/8" x 12"
3-1/2"	11-7/8"	3" x 8"
	14"	3" x 10"
	16"	3" x 12"
3-1/2"	18"	3" x 14"
	20"	3" x 16"
	22"	3" x 18"
	24"	3" x 20"

**NOTES**

- Support back of I-Joist web during nailing to prevent damage to web/flange connection.
- Leave a 1/8" gap between top of filler block and bottom of top I-Joist flange.
- Filler block is required between joists for full length of span.
- Nail joists together with two rows of 10d nails at 12" o.c. (clinched when possible) on each side of the double P3 Joist. Total of 4 nails per foot required. If nails can be clinched, only 2 nails per foot are required.
- The maximum load that may be applied to one side of the double joist using this detail is 620 lbf/ft.

**2p DOUBLE P3 JOIST CONSTRUCTION DETAIL**

**TABLE 2**  
**APA Rated Sturd-I-Floor Fastener Schedules for PJs<sup>1</sup>**

Maximum Joist Spacing [in.]	Panel Thickness <sup>2</sup> [in.]	Nail Size and Type	Fastening: Glued-Nailed <sup>3</sup>	
			Maximum Spacing [in.]	
			Supported Panel Edges	Intermediate Supports
16	23/32 <sup>5</sup>	6d ring- or screw-shank <sup>4</sup>	12	12
20	23/32 <sup>5</sup>	6d ring- or screw-shank <sup>4</sup>	12	12
24	23/32, 3/4	6d ring- or screw-shank <sup>4</sup>	12	12
	7/8	8d ring- or screw-shank <sup>4</sup>	6	12

- Wipe any mud, dirt, water, or ice from P3 Joist flanges before gluing.
- Snap a chalk line across the P3 Joist four feet in from the wall for panel edge alignment and as a boundary for spreading glue.
- Spread only enough glue to lay one or two panels at a time, or follow specific recommendations from the glue manufacturer.
- Lay the first panel with tongue side to the wall, and nail in place. This protects the tongue of the next panel from damage when tapped into place with a block and sledgehammer.
- Apply a continuous line of glue (about 1/4" diameter) to the top flange of a single P3 Joist. Apply glue in a winding pattern on wide areas such as with double Power Joists.
- Apply two lines of glue on P3 Joists where panel ends butt to assure proper gluing of each end.
- After the first row of panels is in place, spread glue in the groove of one or two panels at a time before laying the next row. Glue line may be continuous or spaced, but avoid squeeze-out by applying a thinner line (1/8") than used on P3 Joist flanges.
- Tap the second row of panels into place, using a block to protect groove edges.
- Stagger end joints in each succeeding row of panels. A 1/8" space between all end joints and 1/8" at all edges, including T&G edges, is recommended. (Use a spacer tool or an 8d common nail to ensure accurate and consistent spacing.)
- Complete all nailing of each panel before glue sets. Check the manufacturer's recommendations for allowable cure time. (Warm weather accelerates glue setting.) Use 6d ring- or screw-shank nails for panels 3/4" thick or less and 8d ring- or screw-shank nails for thicker panels. Space nails per Table 3. Closer nail spacing may be required by some codes or for diaphragm construction. The finished deck can be walked on right away and will carry construction loads without damage to the glue bond.

- NOTES**
- Special conditions may impose heavy traffic and concentrated loads that require construction in excess of the minimums shown.
  - Panels in a given thickness may be manufactured in more than one allowable span. Panels with an allowable span greater than the actual joist spacing may be substituted for panels of the same thickness with an allowable span matching the actual joist spacing. For example, 19/32-inch-thick Sturd-I-Floor 20 o.c. may be substituted for 19/32-inch-thick Sturd-I-Floor 16 o.c. over joists 16 inches on center.
  - Use only adhesives conforming to APA Specification AFG-01 or ASTM D3498. Apply adhesives in accordance with the manufacturer's recommendations. If OSB panels with sealed surfaces and edges are to be used, use only solvent-based glues; check with panel manufacturer.
  - 8d common nails may be substituted if ring- or screw-shank nails are not available.
  - The recommended minimum thickness for use with P3 Joist.

**IMPORTANT NOTE**  
Floor sheathing must be field glued to the Power Joist flanges in order to achieve the allowable spans stamped on the product. If sheathing is nailed only, reduce Power Joist spans in Tables 1 and 1a by 1'-0".

## Cantilever Details for Interior Balconies (No Wall Load)

FIGURE 3

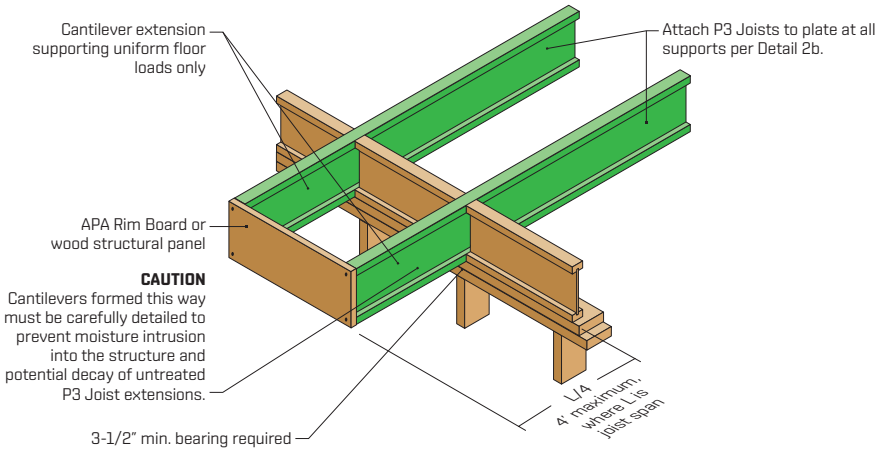

Balconies may be constructed by using either continuous P3 Joists (Figure 3) or by adding lumber extensions (Figure 4) to the P3 Joist. Continuous P3 Joist cantilevers are limited to one-fourth the adjacent span when supporting uniform loads only. For applications supporting concentrated loads at the end of the cantilever such as a wall, see Figures 5a and 5b.

Unless otherwise engineered, cantilevers are limited to a maximum of 4' when supporting uniform loads only. Blocking is required at the cantilever support as shown.

Uniform floor load shall not exceed 40 psf live load and 10 psf dead load. The balcony load shall not exceed 60 psf live load and 10 psf dead load.

## Lumber Cantilever Details For Balconies (No Wall Load)

FIGURE 4

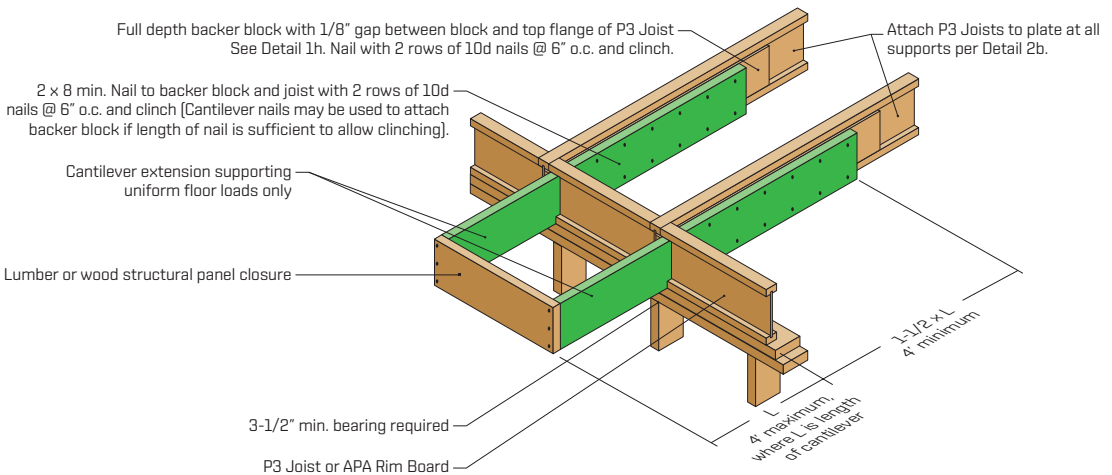

**NOTES** All nails shown in the details above are assumed to be common nails unless otherwise noted. Individual components are not shown to scale for clarity.

# Cantilever Detail for Vertical Building Offset [Concentrated Wall Load]

**FIGURE 5A**

**Method 1**

Sheathing Reinforcement One Side

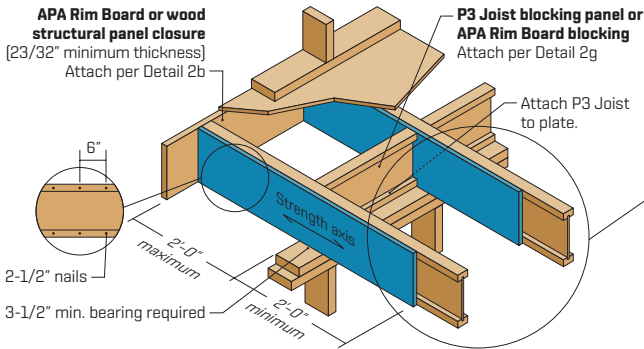

**Method 2**

Sheathing Reinforcement Two Sides

Use same installation as Method 1, but reinforce both sides of the P3 Joist with sheathing or APA Rim Board.

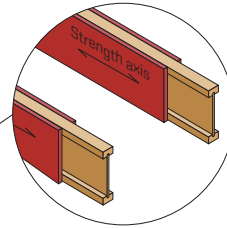

Use nailing pattern shown for Method 1 with opposite face nailing offset by 3".

**NOTE** APA RATED SHEATHING 4B/24 [minimum thickness 23/32"] required on sides of joist. Depth shall match the full height of the joist. Nail top and bottom flange with 2-1/2" nails at 6" o.c. Install with face grain running horizontally. Attach P3 Joist to plate at all supports per Detail 2b.

P3 Joists may also be used in cantilever applications, supporting a concentrated load applied to the end of the cantilever such as with a vertical building offset. For cantilever-end concentrated load applications that require reinforcing based on Table 3, the cantilever is limited to 2' maximum. In addition, blocking is required along the cantilever support and is required for 4' on each side of the cantilever area. Subject to the roof loads and layout [see Table 3], three methods of reinforcing are allowed in load bearing cantilever applications: reinforcing sheathing applied to one side of the P3 Joist [Method 1], reinforcing sheathing applied to both sides of the P3 Joist [Method 2], or double P3 Joist [Alternate Method 2].

**Alternate Method 2**

Double P3 Joist

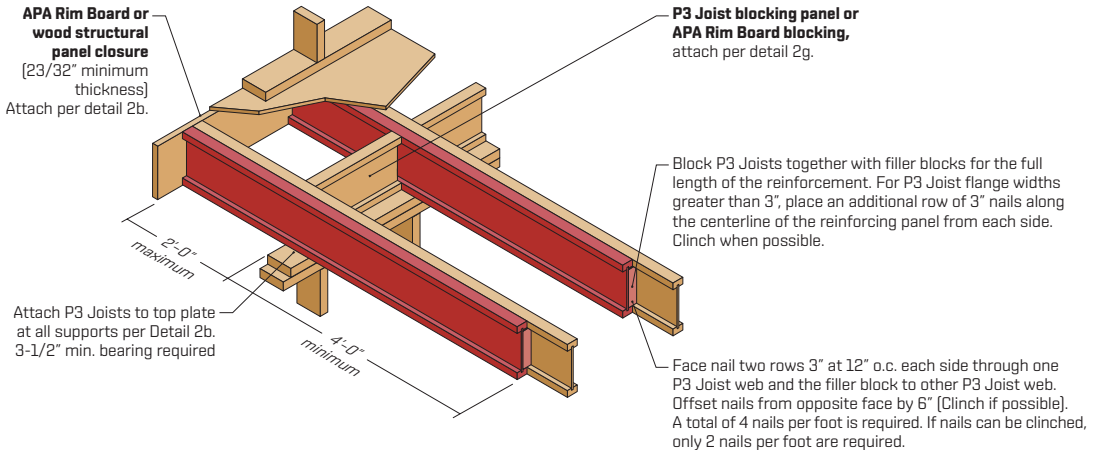

**NOTES** All nails shown in the details above are assumed to be common nails unless otherwise noted. Individual components are not shown to scale for clarity.

# Cantilever Details for Vertical Building Offset (Concentrated Wall Load)

FIGURE 5B

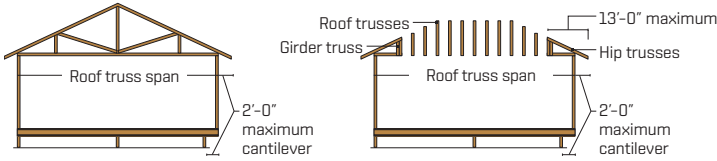

See Table below for P3 Joist reinforcement requirements at cantilever.

For hip roofs with the hip trusses running parallel to the cantilevered floor joists, the P3 Joist reinforcement requirements for a span of 26 ft. shall be permitted to be used.

Source: APA

## Cantilever Reinforcement Methods

TABLE 3

P3 Joist Cantilever Reinforcement Methods Allowed

Joist Depth (in.)	Roof Truss Span (ft)	ROOF LOADINGS											
		TL = 35 psf LL not to exceed 20 psf Joist Spacing (in.)				TL = 45 psf LL not to exceed 30 psf Joist Spacing (in.)				TL = 55 psf LL not to exceed 40 psf Joist Spacing (in.)			
		12	16	19.2	24	12	16	19.2	24	12	16	19.2	24
9-1/2	26	N	N	N	1	N	N	1	2	N	1	2	X
	28	N	N	N	1	N	N	1	2	N	1	2	X
	30	N	N	1	1	N	N	1	2	N	1	2	X
	32	N	N	1	2	N	1	1	X	N	1	2	X
	34	N	N	1	2	N	1	2	X	N	2	X	X
	36	N	N	1	2	N	1	2	X	N	2	X	X
11-7/8	26	N	N	N	1	N	N	1	1	N	1	1	2
	28	N	N	1	1	N	1	1	1	N	1	1	2
	30	N	N	1	1	N	1	1	2	N	1	1	2
	32	N	N	1	1	N	1	1	2	N	1	1	2
	34	N	N	1	1	N	1	1	2	N	1	2	2
	36	N	N	1	1	N	1	1	2	N	1	2	2
14	26	N	N	N	1	N	N	N	1	N	N	1	1
	28	N	N	N	1	N	N	1	1	N	N	1	2
	30	N	N	N	1	N	N	1	1	N	1	1	2
	32	N	N	N	1	N	N	1	1	N	1	1	2
	34	N	N	N	1	N	N	1	2	N	1	1	2
	36	N	N	1	1	N	1	1	2	N	1	1	2
16	26	N	N	N	1	N	N	1	1	N	N	1	1
	28	N	N	N	1	N	N	1	1	N	N	1	2
	30	N	N	N	1	N	N	1	1	N	1	1	2
	32	N	N	N	1	N	N	1	1	N	1	1	2
	34	N	N	1	1	N	N	1	2	N	1	1	2
	36	N	N	1	1	N	1	1	2	N	1	1	2
18	26	N	N	N	1	N	N	1	1	N	N	1	1
	28	N	N	N	1	N	N	1	1	N	N	1	2
	30	N	N	N	1	N	N	1	1	N	1	1	2
	32	N	N	N	1	N	N	1	1	N	1	1	2
	34	N	N	1	1	N	N	1	2	N	1	1	2
	36	N	N	1	1	N	1	1	2	N	1	1	2

**NOTES**

- N = No reinforcement required
- 1 = RJs reinforced with 23/32" wood structural panel on one side only
- 2 = RJs reinforced with 23/32" wood structural panel on both sides or double P3 Joist
- X = Try a deeper joist or closer spacing.
- Color coding in table is matched to details in Figures 5a and 5b.
- Maximum load shall be 15 psf roof dead load, 50 psf floor total load, and 80 plf wall load. Wall load is based on 3'-0" maximum width window or door openings. For larger openings or multiple 3'-0" width openings spaced less than 6'-0" o.c., additional joists beneath the opening's cripple studs may be required.
- Table applies to joists 12" to 24" o.c. Use 12" o.c. requirements for lesser spacings.
- For conventional roof construction using a ridge beam, the Roof Truss Span column above is equivalent to the distance between the supporting wall and the ridge beam. When the roof is framed using a ridge board, the Roof Truss Span is equivalent to the distance between the supporting walls as if a truss is used.
- The detail to the left is appropriate for one and two-family residential structures constructed in accordance with the 2006/2009/2012 International Residential Code (IRC) Sections R301.2.2.2, R602.3(1), and R602.10.
- Cantilevered joists must be properly sized to support all design loads.
- Applications that fall outside of the scope of the 2006/2009/2012 IRC shall be designed in accordance with the 2006/2009/2012 International Building Code (IBC).
- Nail sizes per 2006/2009/2012 IRC:  
8d = 2-1/2" x 0.113"  
10d = 3" x 0.128"  
16d = 3-1/2" x 0.135"

**P3 Joist CANTILEVER DETAIL - NOTES**

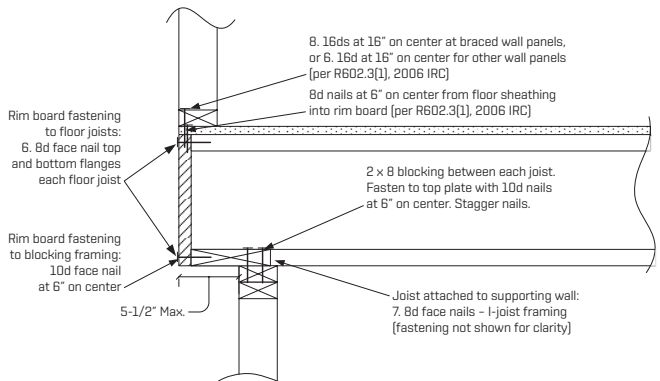

# Web Hole Rules and Specifications

One of the benefits of using P3 Joists in residential floor construction is that holes may be cut in the joist webs to accommodate electrical wiring, plumbing lines, and other mechanical systems, thereby minimizing the depth of the floor system.

## Rules for Cutting Holes in P3 Joists

1. The distance between the inside edge of the support and the center line of any hole shall be in compliance with the requirements of Table 4.
2. P3 Joist top and bottom flanges must **NEVER** be cut, notched, or otherwise modified.
3. Whenever possible field-cut holes should be centered on the middle of the web.
4. The maximum size hole that can be cut into a P3 Joist web shall equal the clear distance between the flanges of the P3 Joist minus 1/4". A minimum of 1/8" should always be maintained between the top or bottom of the hole and the adjacent P3 Joist flange.
5. The sides of square holes or longest sides of rectangular holes should not exceed three-fourths of the diameter of the maximum round hole permitted at that location.
6. Where more than one hole is necessary, the distance between adjacent hole edges shall exceed twice the diameter of the largest round hole or twice the size of the largest square hole (or **twice the length of the longest side of the longest rectangular hole**) and each hole must be sized and located in compliance with the requirements of Table 4.
7. Holes measuring 1-1/2" shall be permitted anywhere in a cantilevered section of a P3 Joist. Holes of greater size may be permitted subject to verification.
8. A 1-1/2" hole can be placed anywhere in the web provided that it meets the requirements of rule 6 above.
9. All holes shall be cut in a workman-like manner in accordance with the restrictions listed above and as illustrated in Figure 6.
10. Limit of 3 maximum size holes per span.
11. A group of round holes at approximately the same location shall be permitted if they meet the requirements for a single round hole circumscribed around them.

## P3 Joist Typical Holes

FIGURE 6

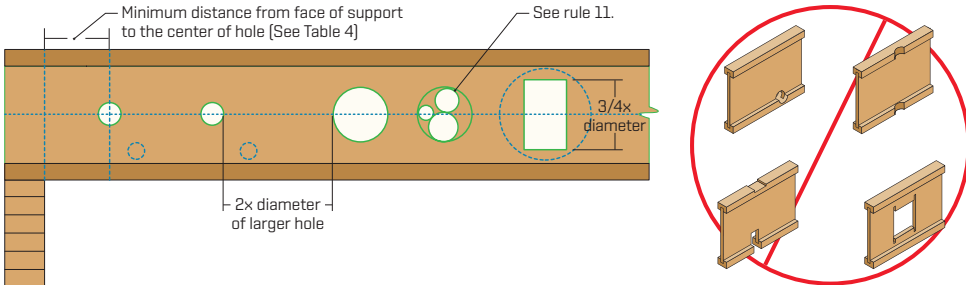

### Cutting the Holes

- **Never** drill, cut, or notch the flange. **Never** over-cut the web.
- Holes in webs should be cut with a sharp saw.
- For rectangular holes avoid over cutting the corners as this can cause unnecessary stress concentrations. Slightly rounding the corners is recommended. Starting the rectangular hole by drilling a 1" diameter hole in each of the 4 corners and then making the cuts between the holes is another good method to minimize damage to I-Joist.

### Do Not Cut or Drill

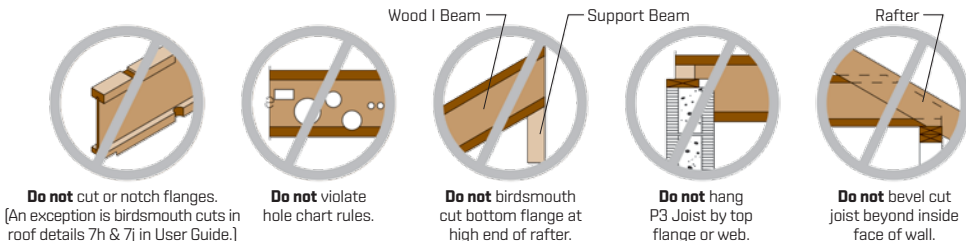

# Web Hole Rules and Specifications (continued)

**TABLE 4**

## Location Of Circular Holes In P3 Joist Webs

Simple or Multiple Span for Dead Loads up to 10 psf and Live Loads up to 40 psf<sup>1,2,3,4</sup>

Joist Depth	Joist	Minimum distance from inside face of any support to center of hole [ft.-in.]															
		Round Hole Diameter [in.]															
		SAF <sup>(5)</sup>	2	3	4	5	6	6-1/4	7	8	8-5/8	9	10	10-3/4	11	12	12-3/4
9-1/2"	PJI 40	14'-6"	0'-7"	1'-8"	3'-0"	4'-4"	5'-9"	6'-3"	2	N	1	2	X				
	PJI 60	15'-3"	1'-8"	3'-0"	4'-4"	5'-8"	7'-3"	7'-8"	2	N	1	2	X				
11-7/8"	PJI 40	16'-7"	0'-7"	0'-8"	1'-2"	2'-5"	3'-9"	4'-1"	5'-1"	6'-8"	7'-11"	1	2				
	PJI 60	18'-2"	0'-8"	1'-10"	3'-2"	4'-5"	5'-10"	6'-2"	7'-4"	8'-11"	10'-0"	1	2				
	PJI 80	19'-10"	1'-11"	3'-2"	4'-6"	5'-10"	7'-3"	7'-8"	8'-10"	10'-6"	11'-7"	1	2				
14"	PJI 90	20'-5"	2'-1"	3'-4"	4'-8"	6'-0"	7'-6"	7'-10"	9'-0"	10'-8"	11'-11"	1	2				
	PJI 40	18'-3"	0'-7"	0'-8"	0'-8"	0'-9"	1'-10"	2'-2"	3'-2"	4'-7"	5'-5"	6'-0"	7'-7"	9'-4"			
	PJI 60	19'-9"	0'-7"	0'-8"	0'-8"	1'-7"	3'-2"	3'-6"	4'-9"	6'-6"	7'-8"	8'-4"	10'-4"	11'-11"			
	PJI 80	22'-7"	0'-7"	1'-9"	3'-0"	4'-4"	5'-8"	6'-1"	7'-1"	8'-7"	9'-7"	10'-3"	12'-2"	13'-10"			
16"	PJI 90	23'-2"	0'-7"	1'-9"	3'-0"	4'-4"	5'-8"	6'-1"	7'-1"	8'-8"	9'-10"	10'-7"	12'-8"	14'-4"			
	PJI 40	19'-8"	0'-7"	0'-8"	0'-8"	0'-9"	0'-9"	0'-10"	1'-5"	2'-9"	3'-7"	4'-1"	5'-6"	6'-7"	7'-0"	8'-9"	10'-9"
	PJI 60	19'-9"	0'-7"	0'-8"	0'-8"	0'-9"	0'-9"	0'-10"	1'-10"	3'-6"	4'-6"	5'-2"	7'-3"	8'-11"	9'-6"	11'-10"	13'-9"
	PJI 80	23'-11"	0'-7"	0'-8"	0'-8"	1'-7"	3'-2"	3'-7"	4'-10"	6'-6"	7'-7"	8'-3"	10'-2"	11'-8"	12'-2"	14'-3"	16'-0"
18"	PJI 90	25'-5"	0'-7"	0'-8"	1'-8"	2'-11"	4'-3"	4'-7"	5'-7"	7'-0"	8'-1"	8'-9"	10'-8"	12'-2"	12'-8"	14'-10"	16'-7"
	PJI 40	19'-8"	0'-7"	0'-8"	0'-8"	0'-9"	0'-9"	0'-10"	1'-5"	2'-9"	3'-7"	4'-1"	5'-6"	6'-7"	7'-0"	8'-9"	10'-9"
	PJI 60	19'-9"	0'-7"	0'-8"	0'-8"	0'-9"	0'-9"	0'-10"	1'-10"	3'-6"	4'-6"	5'-2"	7'-3"	8'-11"	9'-6"	11'-10"	13'-9"
20"	PJI 80	27'-3"	0'-7"	0'-8"	0'-8"	0'-11"	2'-3"	2'-8"	3'-9"	5'-2"	6'-1"	6'-8"	8'-3"	9'-6"	9'-11"	11'-8"	13'-0"
	PJI 90	27'-11"	0'-7"	0'-8"	0'-8"	1'-6"	2'-11"	3'-4"	4'-5"	5'-10"	6'-10"	7'-5"	9'-0"	10'-3"	10'-8"	12'-5"	13'-9"
	PJI 40	19'-8"	0'-7"	0'-8"	0'-8"	0'-9"	0'-9"	0'-10"	1'-5"	2'-9"	3'-7"	4'-1"	5'-6"	6'-7"	7'-0"	8'-9"	10'-9"
22"	PJI 60	19'-9"	0'-7"	0'-8"	0'-8"	0'-9"	0'-9"	0'-10"	1'-10"	3'-6"	4'-6"	5'-2"	7'-3"	8'-11"	9'-6"	11'-10"	13'-9"
	PJI 80	23'-11"	0'-7"	0'-8"	0'-8"	1'-7"	3'-2"	3'-7"	4'-10"	6'-6"	7'-7"	8'-3"	10'-2"	11'-8"	12'-2"	14'-3"	16'-0"
24"	PJI 90	31'-5"	0'-7"	0'-8"	0'-8"	0'-9"	0'-9"	0'-10"	1'-1"	2'-0"	3'-3"	4'-2"	5'-9"	6'-9"	7'-1"	8'-6"	9'-9"
	PJI 40	19'-8"	0'-7"	0'-8"	0'-8"	0'-9"	0'-9"	0'-10"	1'-5"	2'-9"	3'-7"	4'-1"	5'-6"	6'-7"	7'-0"	8'-9"	10'-9"

**NOTES**

- Above tables may be used for P3 Joist spacing of 24" on center or less.
- Hole location distance is measured from inside face of supports to center of hole.
- Distances in this chart are based on uniformly loaded joists.
- Hole sizes and/or locations that fall outside of the scope of this table may be acceptable based on analysis of actual hole size, span, spacing, and loading conditions.
- SAF stands for Span Adjustment Factor. SAF is used as defined below.

**OPTIONAL**

Table 4 is based on the P3 Joists being used at their maximum span. If the P3 Joists are placed at less than their full allowable span, the maximum distance from the centerline of the hole to the face of any support [D] as given above may be reduced as follows.

$$D_{\text{reduced}} = \frac{L_{\text{actual}}}{\text{SAF}} \times D$$

Where:  $D_{\text{reduced}}$  = Distance from the inside face of any support to center of hole is reduced for less than-maximum span applications [ft]. The reduced distance shall not be less than 6" from the face of support to edge of the hole.

$L_{\text{actual}}$  = The actual measured span distance between the inside faces of supports [ft]

SAF = Span Adjustment Factor is given in the table above.

D = The minimum distance from the inside face of any support to center of hole from Table 4 above

If  $\frac{L_{\text{actual}}}{\text{SAF}}$  is greater than 1, use 1 in the above calculation for  $\frac{L_{\text{actual}}}{\text{SAF}}$

When calculating hole locations by this optional method, the following minimum distances between the center of the hole and the inside face of the support apply.

Hole Diameter in inches (mm)	2 (51)	3 (76)	4 (101)	5 (127)	6 (152)	6-1/4 (159)	7 (178)	8 (202)	8-5/8 (219)	9 (228)	10 (254)	10-3/4 (273)	11 (279)	12 (305)	12-3/4 (324)
Minimum Distance in feet	0.5	0.5	1	1	1	1.5	1.5	1.5	1.5	1.5	1.5	1.5	1.5	1.5	2
(mm)	(150)	(150)	(300)	(300)	(300)	(450)	(450)	(450)	(450)	(450)	(450)	(450)	(450)	(450)	(600)

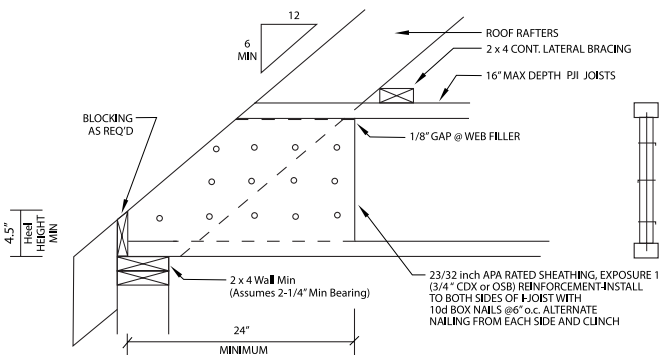

**TAPER CUT JOIST REINFORCEMENT DETAIL**

$$1-1/2" = 1'-0"$$



